

WAREWASHING & STORAGE SYSTEM



Cambox® Bus Boxes



Regal



CODE	1120CBR	1520CBR
DESCRIPTION	Four Compartment Cutlery Box	15" x 20" Cambox
DIM. W x L x H	11 ³ / ₈ " x 20 ¹ / ₁₆ " x 3 ³ / ₄ "	15 ⁵ / ₁₆ " x 19 ¹⁵ / ₁₆ " x 4 ¹⁵ / ₁₆ "
CASE LBS. (CUBE)	22.54 (2.65)	23 (3.54)

Case Pack: 12 Colors: Black (110), Dark Brown (131).



CODE	1621CBR	21155CBR	21157CBR	1722CBR
DESCRIPTION	16" x 21" Cambox	15" x 21" x 5" Cambox	15" x 21" x 7" Cambox	17" x 22" Cambox
DIM. W x L x H	15 ⁵ / ₈ " x 20 ¹ / ₂ " x 4 ⁷ / ₈ "	15 ¹ / ₄ " x 20 ¹ / ₄ " x 4 ¹⁵ / ₁₆ " (includes handle)	15 ⁵ / ₁₆ " x 20 ³ / ₁₆ " x 6 ¹⁵ / ₁₆ "	16 ⁷ / ₈ " x 21 ¹ / ₈ " x 4 ³ / ₄ "
CASE LBS. (CUBE)	42 (3.99)	27.74 (3.94)	35.20 (4.53)	28.24 (4.15)

Case Pack: 12 Colors: Black (110), Dark Brown (131).



Poly

CODE	415CBP	912CBP	1120CBP	1520CBP	1520CBPF*
DESCRIPTION	Cutlery Box	Utility Box	11" x 20" Cambox	15" x 20" Cambox	15" x 20" Cambox
DIM. W x L x H	4 ⁷ / ₁₆ " x 14 ³ / ₁₆ " x 4 ⁷ / ₈ "	9 ¹ / ₁₆ " x 12 ¹ / ₁₆ " x 5 ¹ / ₈ "	11 ³ / ₈ " x 20 ¹ / ₁₆ " x 3 ³ / ₄ "	15 ⁵ / ₁₆ " x 19 ¹⁵ / ₁₆ " x 4 ¹⁵ / ₁₆ "	15 ⁵ / ₁₆ " x 19 ¹⁵ / ₁₆ " x 4 ¹⁵ / ₁₆ "
CASE LBS. (CUBE)	2.6 (0.75)	9.25 (1.22)	20.5 (2.59)	18.61 (3.29)	20.5 (3.54)

Case Pack: 12 Colors: Black (110), Dark Brown (131), Light Gray (180). InStock Color: Light Gray (180). *1520CBPF is identical to 1520CBP except the internal surface is flat.



CODE	1621CBP	21155CBP	21157CBP	1722CBP
DESCRIPTION	15" x 20" Cambox	15" x 21" x 5" Cambox	15" x 21" x 7" Cambox	17" x 22" Cambox
DIM. W x L x H	15 ⁵ / ₈ " x 20 ¹ / ₂ " x 4 ⁷ / ₈ "	15 ¹ / ₄ " x 20 ¹ / ₄ " x 4 ¹⁵ / ₁₆ " (includes handle)	15 ³ / ₁₆ " x 20 ³ / ₁₆ " x 6 ¹⁵ / ₁₆ "	16 ⁷ / ₈ " x 21 ¹ / ₈ " x 4 ³ / ₄ "
CASE LBS. (CUBE)	31.20 (3.89)	21.41 (3.20)	25 (3.73)	26 (4.20)

Case Pack: 12 Colors: Black (110), Dark Brown (131), Light Gray (180). InStock Color: Light Gray (180).

Covers



CODE	1520CBCP	1722CBCP	2115CBCP	2115CBCR
FITS	1520CBP, 1520CBPF 15 x 20 Cambox, Poly	1722CBR, 1722CBP 17 x 22 Cambox, Regal & Poly	21155CBP, 21157CBP 15 x 20 Cambox, Poly	21155CBR, 21157CBR 15 x 20 Cambox, Regal
DIM. W x L	16" x 20 ¹ / ₂ "	17 ⁵ / ₁₆ " x 22 ³ / ₈ "	15 ¹ / ₂ " x 20 ¹ / ₂ "	15 ¹ / ₂ " x 20 ¹ / ₂ "
CASE LBS. (CUBE)	13.08 (1.17)	13.36 (0.93)	12.75 (1.38)	17 (1.40)

Case Pack: 12 Color: White (148).



KD Service Cart and KD Utility Cart



- Versatile, durable and economically-priced carts.
- Marine rails and lightly-textured polypropylene shelves keep contents in place.
- Aluminum uprights ensure stability.
- Ships “knocked down” to minimize shipping costs.
- Easy to assemble.

Cart and Shelf Panel Set Colors:
Black (110), Speckled Gray (480).

Trash Container and Silverware Holder Color: Black (110).



Each BC340KD shelf holds one full-sized dish rack or two standard bus boxes

Optional shelf panels can be added at time of assembly to enclose three sides

Marine rails keep contents in place

Sturdy aluminum uprights

Four powder coated steel swivel casters provide quiet transport and steady maneuvering

Durable, stain-resistant surface is easy to clean



BC340KD



CODE	BC340KD	BC331KD
DESCRIPTION	Utility Cart	Service Cart
CASTER DIA./TYPE	5", 4 swivel, no brake	4", 4 swivel, no brake
OVERALL DIM. L x D x H	40" x 21¼" x 37½"	32⅞" x 16¼" x 38"
SHELF DIM. L x D x H	31½" x 20½" x 11¼"	24⅜" x 15⅞" x 11¼"
LOAD CAPACITY	400 lbs.	300 lbs.
CASE LBS. (CUBE)	39 (6.72)	24.01 (4.07)

Case Pack: 1 InStock Colors: Black (110), Speckled Gray (480).



BC331KD

Optional Accessories



CODE	BC331KDTC	BC331KDSH	BC340KDP
DESCRIPTION	8 gal. Trash Container	2.5 gal. Silverware Holder	Single Shelf Panel Set (for KD Utility Cart only)
DIM. W x D x H	13" x 9½" x 22"	13" x 9½" x 7¼"	31⅞" x 17¼" x 11¼"
CASE LBS. (CUBE)	4.96 (1.92)	2.25 (0.59)	6.25 (0.65)

Case Pack: 1

Service Carts



- All-purpose versatile, durable and dependable workhorses.
- Ideal for use on the receiving dock or setting up and bussing tables.
- Made of one-piece, polyethylene with molded-in handles and shelves.
- Choose from models with open or enclosed sides.

Colors: Black (110), Slate Blue (401), Dark Brown (131), Coffee Beige (157), Gray (180), Granite Gray (191), Granite Green (192).

BC225, BC2254S, BC11TC and BC1115SH can be shipped by parcel carrier.



Open Carts



CODE	BC225	BC2254S	BC235
CASTER DIA./TYPE	3", 2 fixed, 2 swivel, 1 w/brake	3", 4 swivel, 1 w/brake	5", 2 fixed, 2 swivel, 1 w/brake
OVERALL DIM. L x D x H	28" x 16" x 32¼"	28" x 16" x 32¼"	37¼" x 21½" x 34¾"
SHELF DIM. L x D x H	21¾" x 15½" x 11¼"	21¾" x 15½" x 11¼"	31½" x 20¾" x 11¾"
LOAD CAPACITY	350 lbs.	350 lbs.	500 lbs.
CASE LBS. (CUBE)	41 (9.2)	38.8 (9.2)	63.33 (17.63)

Case Pack: 1



CODE	BC2354S	BC230	BC2304S
CASTER DIA./TYPE	5", 4 swivel, 1 w/brake	5", 2 fixed, 2 swivel, 1 w/brake	5", 4 swivel, 1 w/brake
OVERALL DIM. L x D x H	37¼" x 21½" x 34¾"	33¼" x 20" x 34¾"	33¼" x 20" x 34¾"
SHELF DIM. L x D x H	31½" x 20¾" x 11¾"	27" x 19½" x 11¼"	27" x 19½" x 11¼"
LOAD CAPACITY	500 lbs.	500 lbs.	500 lbs.
CASE LBS. (CUBE)	68 (17.85)	62 (15.13)	57.4 (14.77)

Case Pack: 1

Enclosed Carts



CODE	BC330	BC3304S
CASTER DIA./TYPE	5", 2 fixed, 2 swivel, 1 w/brake	5", 4 swivel, 1 w/brake
OVERALL DIM. L x D x H	33⅞" x 20" x 34⅞"	33⅞" x 20" x 34⅞"
SHELF DIM. L x D x H	27" x 18½" x 11¼"	27" x 18½" x 11¼"
LOAD CAPACITY	500 lbs.	500 lbs.
CASE LBS. (CUBE)	64.17 (14.73)	65.2 (14.87)

Case Pack: 1

Optional Accessories



CODE	BC11TC*	BC1115SH*
DESCRIPTION	11 gal. Trash Container	1.75 gal. Silverware Holder
DIMENSIONS W x D x H	13¾" x 8½" x 21½"	14½" x 6" x 5⅝"
CASE LBS. (CUBE)	6 (2.1)	3.25 (0.79)

Case Pack: 1 * BC11TC & BC1115SH will not fit KD Service or Utility Carts. BC11TC & BC1115SH are available in Black (110) and Dark Brown (131) only.

Camdollies®

- Use to transport anything from stacks of sheet pans to catering equipment.
- Reduce employee lifting and carrying and possible injury.
- Made of extremely durable plastic that will not dent, crack, rust or corrode.
- Heavy-duty casters maneuver easily over all types of terrain.
- For heavy transport needs, select models with handles and Rear Big Wheels.

Colors: Coffee Beige (157), Dark Brown (131), Black (110), Slate Blue (401), Gray (180).
CDR2020, CDR2020H Color: Soft Gray (151).

Caster Type

- A:** 5" Casters: 2 fixed, 2 swivel, 1 with brake.
B: 3" Casters: 4 swivel, no brakes.
C: 10" Rear Big Wheels, 2 front 5" swivel casters, 1 with brake.
D: 3½" Casters: 4 swivel, no brakes.

Camdollies Case Pack: 1

*CDR2020H Not NSF Listed.

For Dish Racks

EXTERNAL DIM. W x D x H 21¾" x 21¾" x 8"
INTERIOR DIM. W x D 20⅞" x 20⅞"
CASE LBS. (CUBE) 11.75 (1.14)

350 Lbs. CAPACITY	D CASTER TYPE
-----------------------------	-------------------------



CDR2020
InStock Color: Soft Gray (151)

EXTERNAL DIM. W x D x H 21¾" x 23¾" x 37"
INTERIOR DIM. W x D 20⅞" x 20⅞"
CASE LBS. (CUBE) 21.5 (3.25)

350 Lbs. CAPACITY	D CASTER TYPE
-----------------------------	-------------------------



CDR2020H*
(with powder coated handle)



For 18" x 26" Trays and Sheet Pans

EXTERNAL DIM. W x D x H 20⅞" x 31½" x 38½"
INTERIOR DIM. W x D 18⅞" x 26⅞"
CASE LBS. (CUBE) 33.75 (12.82)



CD1826H

EXTERNAL DIM. W x D x H 22½" x 22½" x 8"
INTERIOR DIM. W x D 20⅞" x 20⅞"
CASE LBS. (CUBE) 16.82 (2.68)

300 Lbs. CAPACITY	B CASTER TYPE
-----------------------------	-------------------------



CD2020

Holds: UPC101

300 Lbs. CAPACITY	A CASTER TYPE
-----------------------------	-------------------------

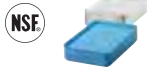

EXTERNAL DIM. W x D x H 23¾" x 33½" x 36½"
INTERIOR DIM. W x D 18⅞" x 26⅞"
CASE LBS. (CUBE) 47 (18.29)



CD1826HB

EXTERNAL DIM. W x D x H 22⅞" x 24⅞" x 36¼"
INTERIOR DIM. W x D 20⅞" x 20⅞"
CASE LBS. (CUBE) 32.25 (11.45)

350 Lbs. CAPACITY	B CASTER TYPE
-----------------------------	-------------------------



CD2020H

Holds: UPC101

300 Lbs. CAPACITY	C CASTER TYPE
-----------------------------	-------------------------

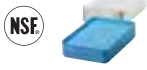

For Pizza Dough Boxes

Also See Pizza Dough Boxes page 91

EXTERNAL DIM. W x D x H 19⅞" x 27⅞" x 10¼"
INTERIOR DIM. W x D 17⅞" x 25⅞"
CASE LBS. (CUBE) 22 (3.67)



CD1826PDB
(Optional Strap Available)

EXTERNAL DIM. W x D x H 26" x 26⅞" x 36⅝"
INTERIOR DIM. W x D 20½" x 20⅞"
CASE LBS. (CUBE) 46 (15.89)

350 Lbs. CAPACITY	C CASTER TYPE
-----------------------------	-------------------------



CD2020HB

Holds: DB18263CW, DB18266CW, DB18263P

300 Lbs. CAPACITY	A CASTER TYPE
-----------------------------	-------------------------



Camdollies®

For Camcarriers® and Camtainers®

EXTERNAL DIM. W x D x H 19³/₄" x 28³/₁₆" x 10¹/₂"
INTERIOR DIM. W x D 17³/₄" x 26³/₁₆"
CASE LBS. (CUBE) 17.5 (3.33)



CD100

Holds: 100MPC, UPC100, UC250,
UC500, 250LCD, 350LCD, 500LCD

300 Lbs. CAPACITY	A CASTER TYPE
-----------------------------	-------------------------



EXTERNAL DIM. W x D x H 23¹⁵/₁₆" x 35⁵/₈" x 36¹/₂"
INTERIOR DIM. W x D 22" x 28¹/₂"
CASE LBS. (CUBE) 35 (17.40)



CD1826MTC

Holds: 1826MTC

350 Lbs. CAPACITY	A CASTER TYPE
-----------------------------	-------------------------



EXTERNAL DIM. W x D x H 19³/₄" x 33³/₈" x 36¹/₄"
INTERIOR DIM. W x D 17³/₄" x 26³/₁₆"
CASE LBS. (CUBE) 33.8 (12.71)



CD100H

Holds: 100MPC, UC250, UC500,
250LCD, 350LCD, 500LCD

350 Lbs. CAPACITY	A CASTER TYPE
-----------------------------	-------------------------

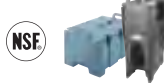

EXTERNAL DIM. W x D x H 27¹/₂" x 34³/₈" x 36³/₄"
INTERIOR DIM. W x D 21¹/₈" x 28³/₁₆"
CASE LBS. (CUBE) 41.8 (21.43)



CD1826MTCB

Holds: 1826MTC

350 Lbs. CAPACITY	C CASTER TYPE
-----------------------------	-------------------------



EXTERNAL DIM. W x D x H 23¹/₂" x 32⁷/₈" x 36¹/₂"
INTERIOR DIM. W x D 17¹/₂" x 26³/₈"
CASE LBS. (CUBE) 45 (18.51)



CD100HB

Holds: 100MPC, UPC100, UC250,
UC500, 250LCD, 350LCD, 500LCD

350 Lbs. CAPACITY	C CASTER TYPE
-----------------------------	-------------------------

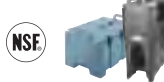

EXTERNAL DIM. W x D x H 19" x 30³/₈" x 36¹/₄"
INTERIOR DIM. W x D 16¹⁵/₁₆" x 23³/₁₆"
CASE LBS. (CUBE) 33 (12.07)



CD300H

Holds: 300MPC, 1318MTC, UC1000, 1000LCD

350 Lbs. CAPACITY	A CASTER TYPE
-----------------------------	-------------------------



EXTERNAL DIM. W x D x H 16⁷/₁₆" x 24³/₈" x 10³/₈"
INTERIOR DIM. W x D 14¹/₁₆" x 21¹⁵/₁₆"
CASE LBS. (CUBE) 19 (2.30)



CD160

Holds: UPC140, UPC160, UPC180,
UPCS140, UPCS160, UPCS180, UPCSS160

300 Lbs. CAPACITY	A CASTER TYPE
-----------------------------	-------------------------



EXTERNAL DIM. W x D x H 23¹/₂" x 29⁷/₈" x 36¹/₂"
INTERIOR DIM. W x D 17³/₄" x 23³/₈"
CASE LBS. (CUBE) 46 (18.11)



CD300HB

Holds: 300MPC, 1318MTC, UC1000, 1000LCD

350 Lbs. CAPACITY	C CASTER TYPE
-----------------------------	-------------------------



EXTERNAL DIM. W x D x H 19³/₈" x 25⁵/₈" x 10³/₈"
INTERIOR DIM. W x D 16¹⁵/₁₆" x 23³/₁₆"
CASE LBS. (CUBE) 17.5 (3.27)



CD300
InStock Color: Black (110)

Holds: 300MPC, 1318MTC, UC1000, 1000LCD

300 Lbs. CAPACITY	A CASTER TYPE
-----------------------------	-------------------------



EXTERNAL DIM. W x D x H 20³/₄" x 27⁵/₈" x 9"
INTERIOR DIM. W x D 18³/₈" x 25"
CASE LBS. (CUBE) 19.60 (3.35)



CD400
(Shown with Optional Strap)
InStock Color: Black (110)

Holds: UPC400, UPCS400, UPCH400

300 Lbs. CAPACITY	A CASTER TYPE
-----------------------------	-------------------------



Camdollies® for Milk Crates and #10 Can Cases

EXTERNAL DIM. W x D x H 16³/₈" x 21¹³/₁₆" x 8"
 INTERIOR DIM. W x D 13¹⁵/₁₆" x 19³/₈"
 CASE LBS. (CUBE) 15.25 (1.44)



CD1420

Holds: 14" x 19" Milk Crates and #10 Can Cases

350 Lbs. CAPACITY	B CASTER TYPE
----------------------	------------------



EXTERNAL DIM. W x D x H 21¹⁵/₁₆" x 30¹/₄" x 8"
 INTERIOR DIM. W x D 19⁹/₁₆" x 27⁷/₈"
 CASE LBS. (CUBE) 18.8 (3.28)



CD2028

Holds: 14" x 19" Milk Crates, #10 Can Cases and UPC101

350 Lbs. CAPACITY	B CASTER TYPE
----------------------	------------------



EXTERNAL DIM. W x D x H 16¹/₄" x 16¹/₂" x 8⁵/₈"
 INTERIOR DIM. W x D 13¹¹/₁₆" x 13¹¹/₁₆"
 CASE LBS. (CUBE) 12.3 (1.11)



CD1313

Holds: 13" x 13" Milk Crates

250 Lbs. CAPACITY	B CASTER TYPE
----------------------	------------------



EXTERNAL DIM. W x D x H 16¹/₄" x 29¹/₄" x 8⁵/₈"
 INTERIOR DIM. W x D 13¹¹/₁₆" x 26³/₄"
 CASE LBS. (CUBE) 14.97 (2.54)



CD1327

Holds: 13" x 13" Milk Crates and #10 Can Cases

300 Lbs. CAPACITY	B CASTER TYPE
----------------------	------------------



Utility Trucks

- Use for transporting loads of up to 600 lbs.
- Large platforms for convenient loading and built-in handles for easy maneuvering.
- All models feature 5" (12,7 cm) heavy-duty casters bolted into molded-in metal backing plates.

Colors: Coffee Beige (157), Dark Brown (131), Black (110), Slate Blue (401), Gray (180), Brick Red (402), Kentucky Green (519).

Casters: 5", 2 fixed, 2 swivel, 1 with brake.

Utility Trucks Case Pack: 1



EXTERNAL DIM. W x D x H 19³/₄" x 32¹/₂" x 38¹/₂"
 LOAD PLATFORM 19³/₄" x 29³/₈"
 CASE LBS. (CUBE) 31 (3.29)



2030UT
(With chrome handle)

600 Lbs. CAPACITY



EXTERNAL DIM. W x D x H 23³/₄" x 41⁵/₈" x 36¹/₄"
 LOAD PLATFORM 23³/₄" x 35¹³/₁₆"
 CASE LBS. (CUBE) 45 (22.93)



2436UTH

600 Lbs. CAPACITY



EXTERNAL DIM. W x D x H 23³/₄" x 41⁵/₈" x 36¹/₄"
 LOAD PLATFORM 23³/₄" x 35¹³/₁₆"
 CASE LBS. (CUBE) 46 (22.93)



2436UTHS
(Includes two straps)

Camdolly® Strap for CD400 and CD1826PDB Camdollies

CODE	400STP
CASE LBS. (CUBE)	1.22 (0.11)
Case Pack: 1	



Tray & Dish Cart / Tray & Silver Cart

Tray & Dish Cart

- Open storage compartment holds a wide variety of plates and trays.
- Use with or without detachable cutlery station.
- Made of easy-to-clean polyethylene that won't rust, peel or corrode.
- Rounded, molded-in corners protect furniture and walls.
- Molded-in handles and heavy-duty 6" (15,2 cm) swivel casters ease maneuvering.

Colors: Slate Blue (401), Coffee Beige (157), Dark Brown (131), Gray (180), Granite Gray (191), Granite Green (192), Black (110).

6" Casters: All swivel, 2 with brake.

Vinyl cover is not NSF listed.



Flatware cylinders and vinyl cover included with TDCR12.

CODE	DESCRIPTION	CASE LBS. (CUBE)
TDCR12	Cart & Rack Combination	88.9 (22.24)
TDC2029*	Cart only	62 (18.14)
CR12	Cutlery Rack only	23.5 (4.46)
FWC56	Flatware Cylinder	2.73 (0.41)

Case Pack: 1 FWC56 Case Pack: 12

CODE	DESCRIPTION	L x W x H
TDCR12	Cart & Rack Combination	38 $\frac{1}{8}$ " x 22 $\frac{3}{4}$ " x 41 $\frac{1}{4}$ "
TDC2029*	Cart	38 $\frac{1}{8}$ " x 22 $\frac{1}{4}$ " x 34 $\frac{1}{4}$ "
CR12	Cutlery Rack	33" x 22 $\frac{3}{4}$ " x 9"

*TDC2029 is not available in Black (110).

Tray & Silver Cart

- Use to neatly organize trays and accessories for self-service.
- Includes eight clear Camwear® food pans to hold flatware, napkins and non-perishable condiments.
- Protective vinyl cover included.

Colors: Slate Blue (401), Coffee Beige (157), Dark Brown (131), Gray (180), Granite Gray (191), Granite Green (192).

6" Casters: All swivel, 2 with brake.

Vinyl cover is not NSF listed.



TC1418

CODE	DESCRIPTION	CASE LBS. (CUBE)
TC1418	Cart w/Pans & Vinyl Cover	84 (19.46)

Case Pack: 1

CODE	EXTERIOR DIMENSIONS L x W x H	WEIGHT CAPACITY	MAXIMUM TRAY SIZE	TRAY CAPACITY
TC1418	32 $\frac{3}{8}$ " x 21 $\frac{1}{4}$ " x 45 $\frac{1}{2}$ "	500 lbs.	14" x 18"	180-200 in two stacks

CAMWEAR® PANS FOR SELF-SERVE TOP:

PAN QUANTITY, SIZE	CAPACITY
4 each, $\frac{1}{3}$ size x 4" deep	Holds 100 knives, 100 spoons, 80 forks
4 each, $\frac{1}{6}$ size x 4" deep	Holds variety of condiments



Vinyl cover included for sanitary storage.



S-Series Adjustable Dish Caddy

- Store one size dish or a combination of different sizes in a single caddy.
- Features easy-to-adjust column towers.

ADCS Colors: Black (110), Slate Blue (401), Speckled Gray (480), Dark Brown (131).

Casters: 5", 2 swivel with brakes and two 10" Easy wheels.

Vinyl cover included. Not NSF listed.

For square and rectangular plates, please contact Cambro for suggested use.



Holds plates and bowls from 4⁵/₈" to 13"

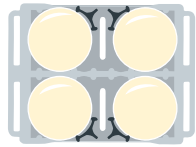

Plate sizes: 9¹/₄" to 13" diam.
4 Columns (60 each)
Total Capacity: 240

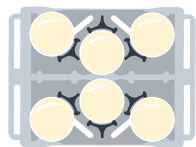

Plate sizes: 7¹/₄" to 9" diam.
6 Columns (60 each)
Total Capacity: 360

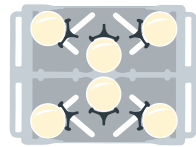
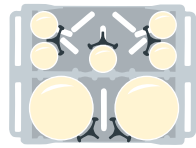
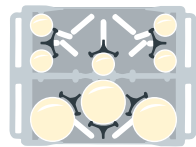

Plate sizes: 5¹/₄" to 7" diam.
6 Columns (45 each)
Total Capacity: 270



2 Columns: 9¹/₄" to 13" diam. (60 each)
5 Columns: 4¹/₈" (45 each)
Total Capacity: 345



3 Columns: 7¹/₄" to 9" diam. (60 each)
5 Columns: 4¹/₈" (45 each)
Total Capacity: 405

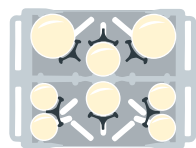

2 Columns: 7¹/₄" to 9" diam. (60 each)
2 Columns: 5¹/₄" to 7" (45 each)
4 Columns: 4¹/₈" (45 each)
Total Capacity: 390

1.800.833.3003



STABLE & SECURE
½" (1,27 cm) rod from top to bottom of divider

ADCS OVERALL DIMENSIONS
W 28³/₈" x L 37¹/₈" x H 31¹/₈"
(73 x 96 x 81 cm)

EASY TO MANEUVER
Ergonomic molded-in handles on both ends

HOLDING CAPACITY
Six 19¹/₂" (49,5 cm) storage columns hold 45-60 plates per stack

EXTREMELY DURABLE
Heavy duty polyethylene construction protects china from chipping. Won't chip, crack or rust

REAR WHEELS
10" (25,4 cm) non-marking Easy Wheels

FRONT CASTERS
5" (12,7 cm) swivel with brake



A ¾" (2 cm) plated steel rear axle allows for 500 lbs. (227 Kg) load capacity.



Vinyl cover included with every dolly for sanitary storage.

CODE	ADCS
NUMBER OF DIVIDERS	6
PLATES PER COLUMN	Approximately 45-60
OVERALL DIMENSIONS W x L x H	28 ³ / ₈ " x 37 ¹ / ₈ " x 31 ¹ / ₈ "
CASE LBS. (CUBE)	133.8 (22.01)
Case Pack: 1	Plate & Bowl size range from 4 ⁵ / ₈ " to 13"
Colors: Black (110), Speckled Gray (480).	

Versa Dish Caddies, Dish Caddies, Adjustable Tray & Dish Cart



Versa Dish Caddies

- Secure, high-capacity storage to protect both square and round plates.
- Durable, polyethylene exterior will not rust, crack, dent or chip.
- Poker chip style offers greater access for easy plate removal.
- A ¾" (2 cm) plated steel rear axle allows for 500 lbs. (227 Kg) load capacity.
- Molded-in handles on both ends for easy transporting.

- Five-inch (12,7 cm) front swivel casters with brake and 10" (25,4 cm) non-marking rear wheels ease maneuvering.
- No assembly required.

Colors: Black (110), Slate Blue (401), Dark Brown (131), Speckled Gray (480).

Casters: 2, 5" swivel with brakes and two 10" Easy Wheels.

Vinyl cover included. Not NSF listed.

DCS950 is covered by U.S. Patent D 603,120 S. DCS1125 is covered by U.S. Patent D 625,894.



DCS950 holds 5 columns of 45-60 round plates up to 9½" (24,1 cm) or 4 to 5 columns of square plates up to 8" (20,5 cm).

DCS1125 holds 4 columns of 45-60 round plates up to 11¼" (28,6 cm) or square plates up to 9½" (24,1 cm).

Poker Chip Style Dish Caddies

- Use to store and protect valuable dishware.
- Dividers are molded into the body in a standard poker chip design.
- Made of durable polyethylene that protects plates from chipping.
- Open access from two sides for easy loading and unloading.
- Rounded corners inside and out protect dishware, furniture and walls.

Colors: Black (110), Slate Blue (401), Dark Brown (131), Granite Gray (191).

Casters: 2, 5" swivel with brakes and two 10" Easy Wheels.

Vinyl cover included. Not NSF listed.



DC700



Sanitary plastic cover included and recommended for protecting clean dinnerware & trays. Replacement covers are available through the Cambro Replacement Parts List at www.cambro.com.

Adjustable Tray & Dish Cart

- Use to store a wide variety of plates and trays.
- Move two adjustable dividers into position easily to secure trays and plates.
- Made of durable polyethylene that cushions plates and trays to prevent chipping.
- Easy to clean and won't dent, rust, chip or break.

Colors: Black (110), Slate Blue (401), Coffee Beige (157), Dark Brown (131), Gray (180), Granite Gray (191), Granite Green (192).

Casters: 6", all swivel, 2 with brake.

Maximum load capacity: 500 lbs.

Vinyl cover included. Not NSF listed.



TDC30



Sanitary plastic cover included.

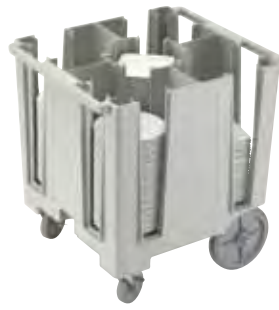

Versa Dish Caddies

CODE	DCS950	DCS1125
PLATE SIZE RANGE (ROUNDS)	8 $\frac{3}{8}$ " - 9 $\frac{1}{2}$ " (21,3 - 24,1 cm)	9 $\frac{5}{8}$ " - 11 $\frac{1}{4}$ " (24,4 - 28,6 cm)
PLATE SIZE RANGE (SQUARES)	7 $\frac{1}{4}$ " - 8" (18,4 - 20,5 cm)	8 $\frac{3}{8}$ " - 9 $\frac{1}{2}$ " (21,3 - 24,1 cm)
COLUMNS PER CADDY	5, 45-60 plates per col.	4, 45-60 plates per col.
OVERALL DIMENSIONS W x L x H	27" x 30 $\frac{1}{2}$ " x 31 $\frac{3}{4}$ "	27" x 30 $\frac{1}{2}$ " x 31 $\frac{3}{4}$ "
CASE LBS. (CUBE)	89.5 (16.64)	89 (16.64)

Case Pack: 1 InStock Colors: Black (110), Speckled Gray (480).

Sanitary plastic cover included with all Cambro dish caddies.



Poker Chip Style Dish Caddies

CODE	DC575	DC700	DC825
PLATE SIZE RANGE	up to 5 $\frac{1}{4}$ " (14,6 cm)	5 $\frac{7}{8}$ " - 7" (14,9 - 17,8 cm)	7 $\frac{1}{8}$ " - 8 $\frac{1}{4}$ " (18,1 - 21 cm)
COLUMNS PER CADDY	6, 45-60 plates per col.	6, 45-60 plates per col.	4, 45-60 plates per col.
OVERALL DIMENSIONS W x L x H	32 $\frac{5}{8}$ " x 23 $\frac{1}{2}$ " x 31 $\frac{3}{4}$ "	32 $\frac{5}{8}$ " x 23 $\frac{1}{2}$ " x 31 $\frac{3}{4}$ "	28 $\frac{3}{4}$ " x 23 $\frac{3}{4}$ " x 32"
CASE LBS. (CUBE)	64 (14.59)	64 (14.59)	58 (12.82)

Case Pack: 1



Poker Chip Style Dish Caddies

CODE	DC1225
PLATE SIZE RANGE	11 $\frac{3}{8}$ " - 12 $\frac{1}{4}$ " (28,9 - 31,1 cm)
COLUMNS PER CADDY	4, 45-60 plates per col.
OVERALL DIMENSIONS W x L x H	32 $\frac{3}{4}$ " x 27 $\frac{1}{2}$ " x 32"
CASE LBS. (CUBE)	71 (17.78)

Case Pack: 1

Adjustable Tray & Dish Cart



CODE	TDC30
NUMBER OF DIVIDERS	2
PLATES PER COLUMN	Approximately 45-60
TRAYS PER COLUMN	80 Trays: 14" x 18"
OVERALL DIMENSIONS W x L x H	23 $\frac{1}{4}$ " x 38 $\frac{3}{8}$ " x 34 $\frac{1}{2}$ "
CASE LBS. (CUBE)	76.67 (18.74)

Case Pack: 1



Camrack® 4-in-1 Warewashing System

The Camrack® System will protect glassware and keep it clean until the next event, eliminating the need for rewashing.

Efficient Washing

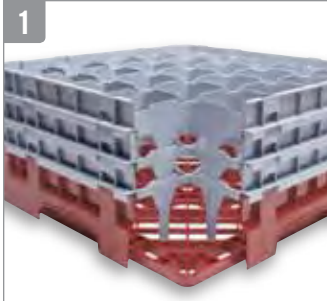

Open inside compartments provide thorough circulation of water and cleaning solutions and promote quick and thorough drying.

Long-lasting polypropylene Camracks are built to withstand chemicals and high temperatures up to 200°F (93°C).

Sanitary Storage



Closed outer walls keep fingers and contaminants out and reduce risk of breakage and injury. The Camrack cover and Camdolly make this system completely enclosed. Glassware stays clean when in storage, so operators will only have to wash items once.

Inventory Control



A variety in base rack colors help identify at a glance both contents and quantity per rack. Available in 10 colors.

Safe, Sanitary Transportation



Camracks can be transported across large campuses or to off-site locations in one single unit.

Easy to grip handles and smooth overlapping sides facilitate safe handling.

Camrack Cover Seals from the Top and Camdolly® Seals from the Bottom



Camracks interstack with racks from major manufacturers.



No Bacteria



No Dirty Hands



No Rodents



No Bugs



No Dirty Mop Water

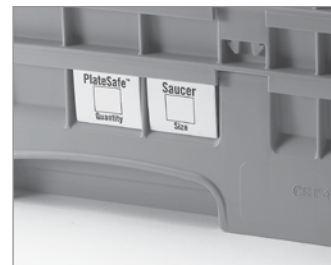

Content labeling options include one-color custom hot stamping or pre-printed clips that are added at factory during assembly.



Camracks are covered by one or more of the following patents: Full Base Dish Rack D412,607. Half Base Dish Rack D404,176. Half Dish Rack Extender D400,321. Enlarged Dish Rack Extender D399,614. Dish Rack with Extender 5,934,486 Utility Patent. Pronged Base Dish Rack D403,472.

Full Size Camracks® for Stemware & Tumblers

These racks offer complete protection for all your delicate and valuable stemware and tumblers, from washing and handling to stacking, storing and transporting.

Choose the correct dishrack:

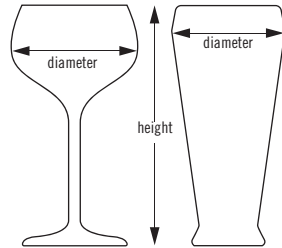

1. Measure the maximum diameter of your glass (stemware or tumbler) to determine the number of compartments.
2. Measure the maximum height of your glass (stemware or tumbler) to the top edge of the rim to determine the compartment height.







25S534

Camrack Sizing Guides are available at www.cambro.com under Resource Center.

9 COMPARTMENT

 5 7/8" 14,8 cm MAXIMUM DIAMETER	 MAXIMUM HEIGHT	3 5/8" 9 cm	5 1/4" 13,2 cm	6 7/8" 17,4 cm	8 1/2" 21,6 cm	10 1/8" 25,8 cm	11 3/4" 30 cm
		CODE	9S318	9S434	9S638	9S800	9S958
CASE PACK		5	4	3	2	2	2
CASE LBS. (CUBE)		28.03 (6.93)	29.26 (6.93)	27.27 (6.38)	22.02 (4.86)	25.10 (5.96)	28.58 (6.93)
CASE KG (CUBE M³)		12,71 (0,196)	13,27 (0,196)	12,37 (0,181)	9,98 (0,138)	11,39 (0,169)	12,96 (0,196)
RACK DIMENSION		19 1/4" x 19 1/4" x 5 5/8" 50 x 50 x 14,3 cm	19 3/4" x 19 3/4" x 7 1/4" 50 x 50 x 18,4 cm	19 3/4" x 19 3/4" x 8 7/8" 50 x 50 x 22,5 cm	19 3/4" x 19 3/4" x 10 1/2" 50 x 50 x 26,7 cm	19 3/4" x 19 3/4" x 12 1/8" 50 x 50 x 30,8 cm	19 3/4" x 19 3/4" x 13 3/4" 50 x 50 x 34,9 cm

16 COMPARTMENT

 4 3/8" 10,9 cm MAXIMUM DIAMETER	 MAXIMUM HEIGHT	3 5/8" 9 cm	4 1/2" 11 cm	5 1/4" 13,2 cm	6 1/8" 15,2 cm	6 7/8" 17,4 cm	7 3/4" 19,4 cm
		CODE	16S318	16S418**	16S434	16S534**	16S638
CASE PACK		5	5	4	4	3	3
CASE LBS. (CUBE)		27.18 (6.93)	28.63 (6.93)	28.62 (6.93)	29.82 (6.93)	26.82 (6.38)	27.72 (6.38)
CASE KG (CUBE M³)		12,33 (0,196)	12,99 (0,196)	12,98 (0,196)	13,52 (0,196)	12,17(0,181)	12,57 (0,181)
RACK DIMENSION		19 1/4" x 19 1/4" x 5 5/8" 50 x 50 x 14,3 cm	19 3/4" x 19 3/4" x 5 5/8" 50 x 50 x 14,3 cm	19 3/4" x 19 3/4" x 7 1/4" 50 x 50 x 18,4 cm	19 3/4" x 19 3/4" x 7 1/4" 50 x 50 x 18,4 cm	19 3/4" x 19 3/4" x 8 7/8" 50 x 50 x 22,5 cm	19 3/4" x 19 3/4" x 8 7/8" 50 x 50 x 22,5 cm
 MAXIMUM HEIGHT		8 1/2" 21,6 cm	9 3/8" 23,8 cm	10 1/8" 25,8 cm	11" 27,8 cm	11 3/4" 30 cm	12 5/8" 32 cm
CODE		16S800	16S900**	16S958	16S1058**	16S1114	16S1214**
CASE PACK		2	2	2	2	2	2
CASE LBS. (CUBE)		21.74 (4.86)	22.34 (4.86)	24.84 (5.96)	25.44 (5.96)	28.34 (6.93)	28.94 (6.93)
CASE KG (CUBE M³)		9,86 (0,138)	10,13 (0,138)	11,27 (0,169)	11,54 (0,169)	12,86 (0,196)	13,13 (0,196)
RACK DIMENSION		19 3/4" x 19 3/4" x 10 1/2" 50 x 50 x 26,7 cm	19 3/4" x 19 3/4" x 10 1/2" 50 x 50 x 26,7 cm	19 3/4" x 19 3/4" x 12 1/8" 50 x 50 x 30,8 cm	19 3/4" x 19 3/4" x 12 1/8" 50 x 50 x 30,8 cm	19 3/4" x 19 3/4" x 13 3/4" 50 x 50 x 34,9 cm	19 3/4" x 19 3/4" x 13 3/4" 50 x 50 x 34,9 cm



Base Rack Colors:





InStock Color: Soft Gray (151). **Extender Color:** Soft Gray (151). ** Compartment Extenders cannot be added. Personalization available. See Camrack personalization and color coding page. Contact Customer Service for all special orders.

Full Size Camracks® for Stemware & Tumblers

20 COMPARTMENT



 <p>3 7/8" 9.84 cm MAXIMUM DIAMETER</p>	MAXIMUM HEIGHT 	3 5/8" 9 cm	5 1/4" 13.2 cm	6 7/8" 17.4 cm	8 1/2" 21.6 cm	10 1/8" 25.8 cm	11 3/4" 30 cm
	CODE	20S318	20S434	20S638	20S800	20S958	20S1114
	CASE PACK	5	4	3	2	2	2
	CASE LBS. (CUBE)	28.10 (6.93)	29.84 (6.93)	28.9 (6.38)	22.91 (4.86)	26.17 (5.96)	29.91 (6.93)
	CASE KG (CUBE M³)	12,77 (0,196)	13,56 (0,196)	12,77 (0,181)	10,41 (0,138)	11,89 (0,169)	13,59 (0,196)
	RACK DIMENSION	19 3/4" x 19 3/4" x 5 5/8" 50 x 50 x 14,3 cm	19 3/4" x 19 3/4" x 7 1/4" 50 x 50 x 18,4 cm	19 3/4" x 19 3/4" x 8 7/8" 50 x 50 x 22,5 cm	19 3/4" x 19 3/4" x 10 1/2" 50 x 50 x 26,7 cm	19 3/4" x 19 3/4" x 12 1/8" 50 x 50 x 30,8 cm	19 3/4" x 19 3/4" x 13 3/4" 50 x 50 x 34,9 cm

25 COMPARTMENT

 <p>3 4/9" 8.7 cm MAXIMUM DIAMETER</p>	MAXIMUM HEIGHT 	3 5/8" 9 cm	4 1/2" 11 cm	5 1/4" 13.2 cm	6 1/8" 15.2 cm	6 7/8" 17.4 cm	7 3/4" 19.4 cm
	CODE	25S318	25S418**	25S434	25S534**	25S638	25S738**
	CASE PACK	5	5	4	4	3	3
	CASE LBS. (CUBE)	28.08 (6.93)	30.13 (6.93)	29.78 (6.93)	31.50 (6.93)	28.02 (6.38)	29.31 (6.38)
	CASE KG (CUBE M³)	12,74 (0,196)	13,67 (0,196)	13,51 (0,196)	14,29 (0,196)	12,71 (0,181)	13,30 (0,181)
	RACK DIMENSION	19 3/4" x 19 3/4" x 5 5/8" 50 x 50 x 14,3 cm	19 3/4" x 19 3/4" x 5 5/8" 50 x 50 x 14,3 cm	19 3/4" x 19 3/4" x 7 1/4" 50 x 50 x 18,4 cm	19 3/4" x 19 3/4" x 7 1/4" 50 x 50 x 18,4 cm	19 3/4" x 19 3/4" x 8 7/8" 50 x 50 x 22,5 cm	19 3/4" x 19 3/4" x 8 7/8" 50 x 50 x 22,5 cm
	MAXIMUM HEIGHT 	8 1/2" 21.6 cm	9 3/8" 23.8 cm	10 1/8" 25.8 cm	11" 27.8 cm	11 3/4" 30 cm	12 5/8" 32 cm
	CODE	25S800	25S900**	25S958	25S1058**	25S1114	25S1214**
	CASE PACK	2	2	2	2	2	2
	CASE LBS. (CUBE)	22.76 (4.86)	23.62 (4.86)	26.08 (5.96)	26.94 (5.96)	29.80 (6.93)	30.66 (6.93)
	CASE KG (CUBE M³)	10,32 (0,138)	10,71 (0,138)	11,83 (0,169)	12,22 (0,169)	13,52 (0,196)	13,91 (0,196)
	RACK DIMENSION	19 3/4" x 19 3/4" x 10 1/2" 50 x 50 x 26,7 cm	19 3/4" x 19 3/4" x 10 1/2" 50 x 50 x 26,7 cm	19 3/4" x 19 3/4" x 12 1/8" 50 x 50 x 30,8 cm	19 3/4" x 19 3/4" x 12 1/8" 50 x 50 x 30,8 cm	19 3/4" x 19 3/4" x 13 3/4" 50 x 50 x 34,9 cm	19 3/4" x 19 3/4" x 13 3/4" 50 x 50 x 34,9 cm



** Compartment Extenders cannot be added.

30 COMPARTMENT

 <p>3 1/8" 7.94 cm MAXIMUM DIAMETER</p>	MAXIMUM HEIGHT 	3 5/8" 9 cm	5 1/4" 13.2 cm	6 7/8" 17.4 cm	8 1/2" 21.6 cm	10 1/8" 25.8 cm	11 3/4" 30 cm
	CODE	30S318	30S434	30S638	30S800	30S958	30S1114
	CASE PACK	5	4	3	2	2	2
	CASE LBS. (CUBE)	29.21 (6.93)	31.33 (6.93)	29.66 (6.38)	24.25 (4.86)	27.8 (5.96)	31.85 (6.93)
	CASE KG (CUBE M³)	13,28 (0,196)	14,24 (0,196)	13,48 (0,181)	11,02 (0,138)	12,64 (0,169)	14,48 (0,196)
	RACK DIMENSION	19 3/4" x 19 3/4" x 5 5/8" 50 x 50 x 14,3 cm	19 3/4" x 19 3/4" x 7 1/4" 50 x 50 x 18,4 cm	19 3/4" x 19 3/4" x 8 7/8" 50 x 50 x 22,5 cm	19 3/4" x 19 3/4" x 10 1/2" 50 x 50 x 26,7 cm	19 3/4" x 19 3/4" x 12 1/8" 50 x 50 x 30,8 cm	19 3/4" x 19 3/4" x 13 3/4" 50 x 50 x 34,9 cm



Full Size Camracks® for Stemware & Tumblers

36 COMPARTMENT

 <p>2 7/8" 7,2 cm MAXIMUM DIAMETER</p> <p>2 7/16" 6 cm MAXIMUM DIAMETER</p>	MAXIMUM HEIGHT 	3 5/8" 9 cm	4 1/2" 11 cm	5 1/4" 13,2 cm	6 1/8" 15,2 cm	6 7/8" 17,4 cm	7 3/4" 19,4 cm
	CODE	36S318	36S418**	36S434	36S534**	36S638	36S738**
	CASE PACK	5	5	4	4	3	3
	CASE LBS. (CUBE)	29.23 (6.93)	31.78 (6.93)	31.54 (6.93)	33.46 (6.93)	29.97 (6.38)	31.41 (6.38)
	CASE KG (CUBE M³)	13,26 (0,196)	14,42 (0,196)	14,31 (0,196)	15,18 (0,196)	13,60 (0,181)	14,25 (0,181)
	RACK DIMENSION	19 1/4" x 19 1/4" x 5 5/8" 50 x 50 x 14,3 cm	19 1/4" x 19 1/4" x 5 5/8" 50 x 50 x 14,3 cm	19 1/4" x 19 1/4" x 7 1/4" 50 x 50 x 18,4 cm	19 1/4" x 19 1/4" x 7 1/4" 50 x 50 x 18,4 cm	19 1/4" x 19 1/4" x 8 7/8" 50 x 50 x 22,5 cm	19 1/4" x 19 1/4" x 8 7/8" 50 x 50 x 22,5 cm
	MAXIMUM HEIGHT 	8 1/2" 21,6 cm	9 3/8" 23,8 cm	10 1/8" 25,8 cm	11" 27,8 cm	11 3/4" 30 cm	12 5/8" 32 cm
	CODE	36S800	36S900**	36S958	36S1058**	36S1114	36S1214**
	CASE PACK	2	2	2	2	2	2
	CASE LBS. (CUBE)	24.48 (4.86)	25.44 (4.86)	28.22 (5.96)	29.18 (5.96)	32.36 (6.93)	33.32 (6.93)
	CASE KG (CUBE M³)	11,10 (0,138)	11,54 (0,138)	12,80 (0,169)	13,24 (0,169)	14,68 (0,196)	15,11 (0,196)
	RACK DIMENSION	19 1/4" x 19 1/4" x 10 1/2" 50 x 50 x 26,7 cm	19 1/4" x 19 1/4" x 10 1/2" 50 x 50 x 26,7 cm	19 1/4" x 19 1/4" x 12 1/2" 50 x 50 x 30,8 cm	19 1/4" x 19 1/4" x 12 1/2" 50 x 50 x 30,8 cm	19 1/4" x 19 1/4" x 13 3/4" 50 x 50 x 34,9 cm	19 1/4" x 19 1/4" x 13 3/4" 50 x 50 x 34,9 cm

** Compartment Extenders cannot be added.

49 COMPARTMENT

 <p>2 7/8" 7,2 cm MAXIMUM DIAMETER</p> <p>2 7/16" 6 cm MAXIMUM DIAMETER</p>	MAXIMUM HEIGHT 	3 5/8" 9 cm	5 1/4" 13,2 cm	6 7/8" 17,4 cm	8 1/2" 21,6 cm	10 1/8" 25,8 cm	11 3/4" 30 cm
	CODE	49S318	49S434	49S638	49S800	49S958	49S1114
	CASE PACK	5	4	3	2	2	2
	CASE LBS. (CUBE)	30.93 (6.93)	33.74 (6.93)	32.25 (6.38)	26.42 (4.86)	30.58 (5.96)	35.14 (6.93)
	CASE KG (CUBE M³)	14,03 (0,196)	15,30 (0,196)	14,63 (0,181)	11,98 (0,138)	13,87 (0,169)	15,94 (0,196)
	RACK DIMENSION	19 1/4" x 19 1/4" x 5 5/8" 50 x 50 x 14,3 cm	19 1/4" x 19 1/4" x 7 1/4" 50 x 50 x 18,4 cm	19 1/4" x 19 1/4" x 8 7/8" 50 x 50 x 22,5 cm	19 1/4" x 19 1/4" x 10 1/2" 50 x 50 x 26,7 cm	19 1/4" x 19 1/4" x 12 1/2" 50 x 50 x 30,8 cm	19 1/4" x 19 1/4" x 13 3/4" 50 x 50 x 34,9 cm

Base Rack Colors:



InStock Color: Soft Gray (151). **Extender Color:** Soft Gray (151). ** Compartment Extenders cannot be added.

Personalization available. See Camrack personalization and color coding page. Contact Customer Service for all special orders.

Half Size Camracks® for Stemware & Tumblers

- Very effective for carrying less weight and for storing drinkware in space-restricted locations.
- Ideal for small under-counter glasswashers.



10HS434

8 COMPARTMENT

Camrack Sizing Guides are available at www.cambro.com under Resource Center.

<p>4 1/8" 10,3 cm MAXIMUM DIAMETER</p>	MAXIMUM HEIGHT	3 5/8" 9 cm	5 1/4" 13,2 cm	6 7/8" 17,4 cm	8 1/2" 21,6 cm	10 1/8" 25,8 cm	11 3/4" 30 cm
	CODE	8HS318	8HS434	8HS638	8HS800	8HS958	8HS1114
	CASE PACK	5	4	3	2	2	2
	CASE LBS. (CUBE)	16.96 (3.27)	17.94 (3.54)	16.78 (3.27)	13.57 (2.76)	15.67 (3.06)	17.68 (3.27)
	CASE KG (CUBE M³)	7,69 (0,093)	8,14 (0,100)	7,61 (0,093)	6,16 (0,078)	7,11 (0,087)	8,02 (0,093)
	RACK DIMENSION	19 3/4" x 10" x 5 5/8" 50 x 25 x 14,3 cm	19 3/4" x 10" x 7 1/4" 50 x 25 x 18,4 cm	19 3/4" x 10" x 8 5/8" 50 x 25 x 22,5 cm	19 3/4" x 10" x 10 1/2" 50 x 25 x 26,7 cm	19 3/4" x 10" x 12 1/8" 50 x 25 x 30,8 cm	19 3/4" x 10" x 13 3/4" 50 x 25 x 34,9 cm

10 COMPARTMENT

<p>3 1/2" 8,8 cm MAXIMUM DIAMETER</p>	MAXIMUM HEIGHT	3 5/8" 9 cm	5 1/4" 13,2 cm	6 7/8" 17,4 cm	8 1/2" 21,6 cm	10 1/8" 25,8 cm	11 3/4" 30 cm
	CODE	10HS318	10HS434	10HS638	10HS800	10HS958	10HS1114
	CASE PACK	5	4	3	2	2	2
	CASE LBS. (CUBE)	17.36 (3.27)	18.50 (3.54)	17.38 (3.27)	14.09 (2.76)	16.31 (3.06)	18.44 (3.27)
	CASE KG (CUBE M³)	7,87 (0,093)	8,39 (0,100)	7,88 (0,093)	6,39 (0,078)	7,40 (0,087)	8,36 (0,093)
	RACK DIMENSION	19 3/4" x 10" x 5 5/8" 50 x 25 x 14,3 cm	19 3/4" x 10" x 7 1/4" 50 x 25 x 18,4 cm	19 3/4" x 10" x 8 5/8" 50 x 25 x 22,5 cm	19 3/4" x 10" x 10 1/2" 50 x 25 x 26,7 cm	19 3/4" x 10" x 12 1/8" 50 x 25 x 30,8 cm	19 3/4" x 10" x 13 3/4" 50 x 25 x 34,9 cm

17 COMPARTMENT

<p>2 15/16" 7,3 cm MAXIMUM DIAMETER</p>	MAXIMUM HEIGHT	3 5/8" 9 cm	5 1/4" 13,2 cm	6 7/8" 17,4 cm	8 1/2" 21,6 cm	10 1/8" 25,8 cm	11 3/4" 30 cm
	CODE	17HS318	17HS434	17HS638	17HS800	17HS958	17HS1114
	CASE PACK	5	4	3	2	2	2
	CASE LBS. (CUBE)	18.36 (3.27)	19.82 (3.54)	18.76 (3.27)	15.27 (2.76)	17.75 (3.06)	20.14 (3.27)
	CASE KG (CUBE M³)	8,33 (0,093)	8,99 (0,100)	8,51 (0,093)	6,93 (0,078)	8,05 (0,087)	9,14 (0,093)
	RACK DIMENSION	19 3/4" x 10" x 5 5/8" 50 x 25 x 14,3 cm	19 3/4" x 10" x 7 1/4" 50 x 25 x 18,4 cm	19 3/4" x 10" x 8 5/8" 50 x 25 x 22,5 cm	19 3/4" x 10" x 10 1/2" 50 x 25 x 26,7 cm	19 3/4" x 10" x 12 1/8" 50 x 25 x 30,8 cm	19 3/4" x 10" x 13 3/4" 50 x 25 x 34,9 cm

Base Rack Colors:

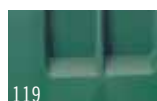

119
Sherwood Green



151
Soft Gray



167
Brown

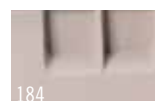

184
Beige



186
Navy Blue



416
Cranberry

Extender Color: Soft Gray (151). Personalization available. See Camrack personalization and color coding page. Contact Customer Service for all special orders.

Camrack® Full & Half Size Cup Racks

Camrack Cup Racks

Tilt feature drains water from mug or cup bases for quick and sanitary drying.

16 COMPARTMENT

4³/₈" X 4³/₈" 11,1 x 11,1 cm COMPARTMENT DIMENSIONS	MAX. HEIGHT 	2⁵/₈" 6,6 cm	4¹/₄" 10,7 cm	5⁷/₈" 14,9 cm
	CODE	16C258	16C414	16C578
	CASE PACK	6	5	4
	CASE LBS. (CUBE)	28.78 (4.81)	32.48 (6.93)	32.86 (6.93)
	CASE KG (CUBE M ³)	13,05 (0,136)	14,73 (0,196)	14,91 (0,196)
	RACK DIMENSION	19 ³ / ₄ " x 19 ³ / ₄ " x 4" 50 x 50 x 10,1 cm	19 ³ / ₄ " x 19 ³ / ₄ " x 5 ⁵ / ₈ " 50 x 50 x 14,3 cm	19 ³ / ₄ " x 19 ³ / ₄ " x 7 ¹ / ₂ " 50 x 50 x 18,4 cm



16C414

InStock Color: Soft Gray (151).

20 COMPARTMENT

4³/₈" X 3¹/₂" 11,1 x 8,8 cm COMPARTMENT DIMENSIONS	MAX. HEIGHT 	2⁵/₈" 6,6 cm	4¹/₄" 10,7 cm
	CODE	20C258	20C414
	CASE PACK	6	5
	CASE LBS. (CUBE)	29.28 (4.81)	32.53 (6.93)
	CASE KG (CUBE M ³)	13,28 (0,136)	14,76 (0,196)
	RACK DIMENSION	19 ³ / ₄ " x 19 ³ / ₄ " x 4" 50 x 50 x 10,1 cm	19 ³ / ₄ " x 19 ³ / ₄ " x 5 ⁵ / ₈ " 50 x 50 x 14,3 cm



InStock Color: Soft Gray (151).

Glass and Cup Keepers

Color: Beige (133).

- Raised ribs for easy draining and drying.
- Holds 20 glasses or 12 cups per layer.



8 COMPARTMENT

4¹/₈" X 4⁷/₁₆" 10,4 x 11,3 cm COMPARTMENT DIMENSIONS	MAX. HEIGHT 	2⁵/₈" 6,6 cm	4¹/₄" 10,7 cm
	CODE	8HC258	8HC414
	CASE PACK	6	5
	CASE LBS. (CUBE)	16.15 (2.76)	18.66 (3.27)
	CASE KG (CUBE M ³)	7,32 (0,078)	8,46 (0,093)
	RACK DIMENSION	19 ³ / ₄ " x 9 ⁷ / ₈ " x 4" 50 x 25 x 10,1 cm	19 ³ / ₄ " x 9 ⁷ / ₈ " x 5 ⁵ / ₈ " 50 x 25 x 14,3 cm



Max. Glass Inside Rim Diameter:
GK2000: 2⁵/₈" (6,6 cm)

Max. Cup Inside Rim Diameter:
KK1200: 2¹⁵/₁₆" (7,4 cm)

10 COMPARTMENT

4¹/₈" X 3¹/₂" 10,4 x 8,8 cm COMPARTMENT DIMENSIONS	MAX. HEIGHT 	2⁵/₈" 6,6 cm	4¹/₄" 10,7 cm
	CODE	10HC258	10HC414
	CASE PACK	6	5
	CASE LBS. (CUBE)	16.73 (2.76)	19.76 (3.27)
	CASE KG (CUBE M ³)	7,59 (0,078)	8,96 (0,093)
	RACK DIMENSION	19 ³ / ₄ " x 9 ⁷ / ₈ " x 4" 50 x 25 x 10,1 cm	19 ³ / ₄ " x 9 ⁷ / ₈ " x 5 ⁵ / ₈ " 50 x 25 x 14,3 cm



CODE	SIZE	CASE LBS. (CUBE)
Glass Keepers		
GK2000	14" x 18"	16 (0.94)
Cup Keepers		
KK1200	13 ¹⁵ / ₁₆ " x 17 ⁷ / ₈ "	14.25 (0.78)
Case Pack: 12		

Base Cup Rack Color: Soft Gray (151). Extender Color: Soft Gray (151). Personalization available. See Camrack personalization and color coding page.

Contact Customer Service for all special orders.

www.cambro.com

Camrack® Base Racks

- For pots, pans, bowls and large prep, service and display items.
- Half racks work well for storing items at a wait station.



BR578



FULL SIZE BASE RACKS

	FULL BASE RACK	WITH 1 EXTENDER	WITH 2 EXTENDERS	WITH 3 EXTENDERS
CODE	BR258	BR414	BR578	BR712
INSIDE RACK HEIGHT	3¼" (8,3 cm)	4⅞" (12,4 cm)	6½" (16,5 cm)	8⅞" (20,6 cm)
OUTSIDE RACK HEIGHT	4" (10,1 cm)	5⅝" (14,3 cm)	7¼" (18,4 cm)	8⅞" (22,5 cm)
CASE PACK	6	5	4	3
CASE LBS. (CUBE)	22.02 (4.81)	24.58 (6.93)	24.98 (6.93)	22.92 (6.38)
CASE KG (CUBE M³)	9,99 (0,136)	11,15 (0,196)	11,33 (0,196)	10,39 (0,181)
RACK DIMENSION	19¾" x 19¾" x 4" 50 x 50 x 10,1 cm	19¾" x 19¾" x 5⅝" 50 x 50 x 14,3 cm	19¾" x 19¾" x 7¼" 50 x 50 x 18,4 cm	19¾" x 19¾" x 8⅞" 50 x 50 x 22,5 cm

InStock Color: Soft Gray (151).



HALF SIZE BASE RACKS

	HALF BASE RACK	WITH 1 EXTENDER	WITH 2 EXTENDERS	WITH 3 EXTENDERS
CODE	HBR258	HBR414	HBR578	HBR712
INSIDE RACK HEIGHT	3¼" (8,3 cm)	4⅞" (12,4 cm)	6½" (16,5 cm)	8⅞" (20,6 cm)
OUTSIDE RACK HEIGHT	4" (10,1 cm)	5⅝" (14,3 cm)	7¼" (18,4 cm)	8⅞" (22,5 cm)
CASE PACK	6	5	4	3
CASE LBS. (CUBE)	13.72 (2.76)	16.06 (3.27)	16.66 (3.54)	15.40 (3.27)
CASE KG (CUBE M³)	6,22 (0,078)	7,29 (0,093)	7,56 (0,100)	6,99 (0,093)
RACK DIMENSION	19¾" x 9⅞" x 4" 50 x 25 x 10,1 cm	19¾" x 9⅞" x 5⅝" 50 x 25 x 14,3 cm	19¾" x 9⅞" x 7¼" 50 x 25 x 18,4 cm	19¾" x 9⅞" x 8⅞" 50 x 25 x 22,5 cm

Hold Down Grid

Keeps lightweight smallwares in place during wash cycle. Use on full size Camrack base rack.



CRPHDG2878

	FULL SIZE HOLD DOWN GRID
CODE	CRPHDG2878
CASE LBS. (CUBE)	11.05 (0.49)
CASE KG (CUBE M³)	4,60 (0,013)

Case Pack: 6 Color: Gray (000).

Base Rack Colors:

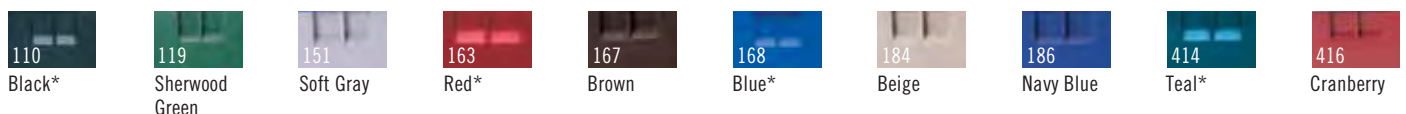

* Full size only. Extender Color: Soft Gray (151). Personalization available. See Camrack personalization and color coding page. Contact Customer Service for all special orders.

Camrack® Full Size Peg Racks & Tray Rack

Standard 9 x 9 Peg Rack

- Designed to wash varying sized plates, bowls, trays and plate covers.
- Standard peg racks hold:
 - Eighteen 10" (25,4 cm) plates
 - Twelve 12" (30,5 cm) plates
 - Twenty-seven 7½" (19 cm) plates
 - or
 - Nine 14" x 18" (36 x 46 cm) trays

5 x 9 Peg Rack

- Holds standard plates in one direction or deep plates, bowls and plate covers in the other direction.
- 5 spacing configuration holds up to ten 10" bowls, deep plates, platters or plate covers.

- 9 spacing configuration holds up to:
 - Eighteen 10" (25,4 cm) plates
 - Twelve 12" (30,5 cm) plates
 - Twenty-seven 7½" (19 cm) plates
 - or
 - Nine 14" x 18" (36 x 46 cm) trays

Open End Tray Rack

- Holds cafeteria trays or full-size sheet pans.
- Open-ended on one side for easy placement and removal of trays of all lengths.
- Holds up to nine trays upright.



	9 X 9 PEG RACK	9 X 9 PEG RACK WITH 1 EXTENDER	5 X 9 PEG RACK	5 X 9 PEG RACK WITH 1 EXTENDER	OPEN END TRAY RACK
CODE	PR314	PR500	PR59314	PR59500	OETR314*
INSIDE RACK HEIGHT	3¼" (8,3 cm)	4⅞" (12,4 cm)	3¼" (8,3 cm)	4⅞" (12,4 cm)	3¼" (8,3 cm)
OUTSIDE RACK HEIGHT	4" (10,1 cm)	5⅝" (14,3 cm)	4" (10,1 cm)	5⅝" (14,3 cm)	4" (10,1 cm)
CASE PACK	6	5	6	5	6
CASE LBS. (CUBE)	27.25 (4.81)	29.28 (6.93)	24.15 (4.81)	26.93 (6.93)	25.84 (4.81)
CASE KG (CUBE M³)	12,36 (0,136)	13,28 (0,196)	10,95 (0,136)	12,22 (0,196)	11,72 (0,136)

Color: Soft Gray (151). **Extender Color:** Soft Gray (151). **InStock Color:** Soft Gray (151). Personalization available. See Camrack personalization and color coding page. Contact Customer Service for all special orders. *Extenders may be added to all Peg Racks except the OETR314.

Camrack Full & Half Size Flatware Racks & Cylinders

Camrack Flatware Racks

- 8 Compartment Basket fits into a Full or Half Size Base Rack. Wire handles slide down for easy storage.
- Flatware Cylinder fits into 9-compartment Full Size Camrack and the Cambro Tray and Dish Cart, model TDCR12.



	FULL FLATWARE RACK	HALF FLATWARE RACK	8 COMPARTMENT HALF FLATWARE BASKET	8 COMPARTMENT HALF FLATWARE BASKET	FLATWARE CYLINDER
CODE	FR258	HFR258	8FB434* With Handles	8FBNH434* No Handles	FWC56
INSIDE RACK HEIGHT	2⅝" (6,7 cm)	2⅝" (6,7 cm)	4¾" (12 cm)	4¾" (12 cm)	4½" wide (11,43 cm)
OUTSIDE RACK HEIGHT	4" (10,1 cm)	4" (10,1 cm)	7¼" (18,4 cm)	7¼" (18,4 cm)	5½" high (13,97 cm)
CASE PACK	6	6	6	6	12
CASE LBS. (CUBE)	24.79 (4.81)	15.26 (2.76)	19.49 (3.67)	17.46 (3.67)	2.76 (0.41)
CASE KG (CUBE M³)	11,25 (0,136)	6,92 (0,078)	8,17 (0,105)	8,16 (0,105)	1,24 (0,012)

Color: Soft Gray (151). **Extender Color:** Soft Gray (151). **InStock Color:** Soft Gray (151). **Flatware Cylinder Color:** White (148). Personalization available. See Camrack personalization and color coding page. Contact Customer Service for all special orders. * Extenders cannot be added.

PlateSafe® Camrack®

- Effectively store and transport dinnerware.
- Vinyl-coated steel grids safely hold and separate plates within each rack.
- Add a Camdolly® and Cover to create a completely enclosed, sanitary storage unit between uses.
- Reduces breakage.
- Holds plates upright and securely in place.
- No need to transfer to dish caddies, reducing labor.



CRPH1656
Half Size PlateSafe Camrack



Transport racks to banquet area for quick set up.



PlateSafe Camracks

13 different styles of full size PlateSafe Camracks to transport plates from 4" to 12½" (10,1-31,7 cm) in diameter.

Portable Sanitary Storage System

Completely enclose and protect dinnerware by stacking racks on a Camdolly and covering with a Camrack cover.

PLATE SIZE	4-5"	4-6"	5-6"	6-7"	6-7 ⁵ / ₈ "	7-8 ⁵ / ₈ "	9-10 ¹ / ₄ "	9-10 ¹ / ₂ "
	10,1-12,7 cm	10,1-15,2 cm	12,7-15,2 cm	15,2-17,7 cm	15,2-19,3 cm	17,7-21,9 cm	22,8-26 cm	22,8-26,6 cm
MAX. PLATE HEIGHT	¾" (1,9 cm)	2" (5 cm)	¾" (1,9 cm)	¾" (1,9 cm)	1" (2,5 cm)	1" (2,5 cm)	1" (2,5 cm)	1½" (4,4 cm)
# OF PLATES	63	20	48	44	30	28	20	12
CODE	CRP6345	CRP2046	CRP4856	CRP4467	CRP3067	CRP2878	CRP20910	CRP12910
RACK SIZE	FULL	FULL	FULL	FULL	FULL	FULL	FULL	FULL
EXT. RACK HEIGHT	7¼" (18,4 cm)	7¼" (18,4 cm)	7¼" (18,4 cm)	8½" (22,5 cm)	8½" (22,5 cm)	10½" (26,7 cm)	12½" (30,8 cm)	12½" (30,8 cm)
CASE PACK	2	2	2	2	2	1	1	1
CASE LBS (CUBE)	22.45 (3.43)	17.44 (3.48)	20.54 (3.43)	31.42 (4.27)	19.5 (4.03)	12.94 (2.59)	14.08 (2.97)	11.1 (2.83)
CASE KG (CUBE M³)	8,71 (0,092)	7,17 (0,092)	8,35 (0,092)	9,39 (0,114)	8,85 (0,114)	4,9 (0,07)	5,31 (0,08)	5,03 (0,08)

PLATE SIZE	9-11 ¹ / ₈ "	9-11"	10-11"	10 ¹ / ₂ -12 ¹ / ₂ "	11 ¹ / ₂ -12 ¹ / ₂ "	5-6 ⁷ / ₈ "
	22,8-28,2 cm	22,8-27,9 cm	25,4-27,9 cm	26,6-31,7 cm	29,2-31,7 cm	12,7-17,5 cm
MAX. PLATE HEIGHT	1½" (4,4 cm)	2¼" (5,7 cm)	1" (2,5 cm)	1½" (3,4 cm)	1" (2,5 cm)	1" (2,5 cm)
# OF PLATES	12	9	19	14	18	16
CODE	CRP12911	CRP9911	CRP191011	CRP141012	CRP181112	CRPH1656
RACK SIZE	FULL	FULL	FULL	FULL	FULL	HALF
EXT. RACK HEIGHT	12½" (30,8 cm)	12½" (30,8 cm)	12½" (30,8 cm)	13¾" (34,9 cm)	13¾" (34,9 cm)	7¼" (18,4 cm)
CASE PACK	1	1	1	1	1	4
CASE LBS (CUBE)	15.07 (3.08)	11.95 (2.83)	15.42 (3.00)	13.85 (3.26)	14.45 (3.26)	23.52 (3.53)
CASE KG (CUBE M³)	5,49 (0,08)	5,42 (0,08)	5,96 (0,08)	6,28 (0,092)	6,55 (0,092)	10,67 (0,1)



* Full size only. Extender Color: Soft Gray (151). Personalization available. See Camrack personalization and color coding page. Contact Customer Service for all special orders.

Camrack® Accessories

Camrack Cover & Camdolly®

- Use to cover and protect full size Camrack dishracks filled with clean dishware.
- When used with a Camdolly, creates a portable sanitary storage system that protects contents between uses.

- Eliminates the use of messy, wasteful plastic wrap or vinyl covers.



	FULL RACK COVER
CODE	DRC2020
EXTERIOR DIMENSIONS	19 ³ / ₈ " x 19 ³ / ₈ " x 1 ⁵ / ₁₆ " (50 x 50 x 2,4 cm)
CASE LBS. (CUBE)	4.2 (0.34)
CASE KG (CUBE M ³)	0,91 (0,0098)

Case Pack: 1 InStock Color: Gray (180).

	CAMDOLLY	CAMDOLLY WITH HANDLE
CODE	CDR2020	CDR2020H
INTERIOR DIMENSIONS	20 ³ / ₈ " x 20 ³ / ₈ " (53 x 53 cm)	20 ³ / ₈ " x 20 ³ / ₈ " (53 x 53 cm)
EXTERIOR DIMENSIONS	21 ³ / ₈ " x 21 ³ / ₈ " x 8" (54,5 x 54,5 x 20,5 cm)	21 ³ / ₈ " x 23 ³ / ₈ " x 37" (54,5 x 59,5 x 94 cm)
LOAD CAPACITY	350 lbs. (159 Kg)	350 lbs. (159 Kg)
CASE LBS. (CUBE)	11.75 (1.14)	21.50 (3.25)
CASE KG (CUBE M ³)	5,3 (0,03)	9,7 (0,1)

Case Pack: 1 Casters: 3¹/₂" (10 cm) casters, 4 swivel, no brakes.

InStock Color: Soft Gray (151).

Camrack IceExpress Glass Filler

- Dramatically reduces banquet set-up time.
- Fills 25 glasses with ice all at once.
- Reduces breakage and risk of contamination.
- Ice falls directly into glasses with no spills or drips.

CODE	EXTERIOR DIMENSIONS W x D x H	CASE WEIGHT (CUBE)
25SWGf	20" x 20 ¹ / ₂ " x 1 ¹ / ₄ " (50,8 x 50,8 x 3,18 cm)	2.5 lbs. (0.49 ft ³) 1,13 Kg (0,014 m ³)

Case Pack: 1 Color: Black (110).



Selecting The Right Camrack

Selecting the Right Camrack

Cambro offers multiple ways to help you quickly find the right Camrack:

1. www.cambro.com/mycamracks

To quickly find the correct Camrack, please visit www.cambro.com/mycamracks. Select the item you are sizing, enter the measurements and quantity of the item, and the right Camrack will appear on the page.

2. Cambro Catalog

Flip to the back of this section for a convenient stemware and glass sizing reference guide.

3. Cambro Sales Representatives

Contact your local Cambro representative to assist with specifying Camracks, dollies and covers that will fit your glasses and dishware. To find your local representative, refer to the back section of this catalog, visit www.cambro.com or call Cambro Customer Service at 800 833 3003.

4. Send a Sample to Cambro

Send a sample glass to:
CAMBRO
Customer Service Department
5801 Skylab Road
Huntington Beach, CA 92647
Please be sure to include complete contact information and specify if you need full-size or half-size Camracks.

Choose the correct Camrack:

1. Measure the **maximum diameter** of the glass (stemware or tumbler) to determine the number of compartments.
2. Measure the **maximum height** of the glass (stemware or tumbler) to the top edge of the rim to determine the compartment height.

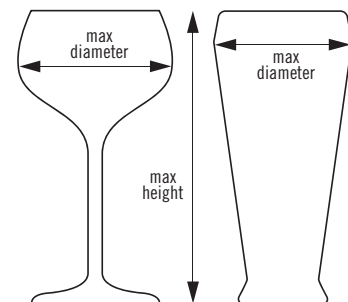

Camrack® Component System

The Camrack System offers several choices for ordering the right Camracks and PlateSafe® Racks. Please consult with your sales representative or Cambro Customer Service for all special ordering and assembly directions.

Choose Between:

1. A complete selection of pre-assembled, ready to use Camracks listed in our catalog, or
2. Custom built special order Camracks for specific needs, or
3. Individual Camrack components for distributors to stock and build racks as needed.

Base Rack Colors:

Sherwood Green (119), Soft Gray (151), Brown (167), Beige (184), Navy Blue (186), Cranberry (416), Black (110)*, Red (163)*, Blue (168)*, Teal (414)*.

Base Cup Rack Color: Soft Gray (151).
Extender Color: Soft Gray (151).

PlateSafe Grid Color: Gray (000).

* Full size only.

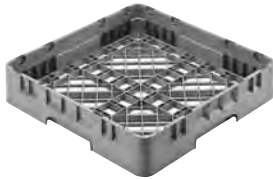

BR = Full Size Base Rack



HBR = Half Size Base Rack



E1 = Full Size Full Drop Compartment Extender



HE1 = Half Size Full Drop Compartment Extender



E2 = Full Size Half Drop Compartment Extender



HE2 = Half Size Half Drop Compartment Extender



E3 = Full Size Open Extender



HE3 = Half Size Open Extender



E4 = Full Size Full Drop Stemware Extender

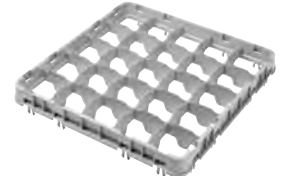

E5 = Full Size Half Drop Stemware Extender

CAMRACK® COMPONENTS

Only E3 extenders may be added to E4's and E5's.

CODE	DESCRIPTION	OVERALL DIMENSIONS	COMPARTMENT	INSIDE RACK HEIGHT	CASE PACK	CASE LBS. (CUBE)
Full Size Base Racks						
BR258	Full Base Rack	19¾" x 19¾" x 4" (500 x 500 x 101 mm)	18" x 18" (457 x 457 mm)	2⅝" (67 mm)	6	22.02 (4.81)
Half Size Base Racks						
HBR258	Half Base Rack	19¾" x 9⅝" x 4" (500 x 250 x 101 mm)	18¾" x 8⅝" (464 x 213 mm)	2⅝" (67 mm)	6	13.72 (2.76)
Full Size Base Cup Racks						
16C258	16-Compartment Full Cup Rack	19¾" x 19¾" x 4" (500 x 500 x 101 mm)	4⅝" x 4⅝" (111 x 111 mm)	2⅝" (67 mm)	6	28.78 (4.81)
20C258	20-Compartment Full Cup Rack	19¾" x 19¾" x 4" (500 x 500 x 101 mm)	4⅝" x 3½" (111 x 89 mm)	2⅝" (67 mm)	6	29.28 (4.81)
Half Size Base Cup Racks						
8HC258	8-Compartment Half Cup Rack	19¾" x 9⅝" x 4" (500 x 250 x 101 mm)	4⅝" x 4⅝" (105 x 113 mm)	2⅝" (67 mm)	6	16.15 (2.76)
10HC258	10-Compartment Half Cup Rack	19¾" x 9⅝" x 4" (500 x 250 x 101 mm)	4⅝" x 3½" (105 x 89 mm)	2⅝" (67 mm)	6	16.73 (2.76)
Full Size Full Drop Extenders – E1 and G1						
9E1	9-Compartment Full Drop Extender	19⅝" x 19⅝" x 2" (499 x 499 x 51 mm)	5⅝" x 5⅝" (150 x 150 mm)	1⅝" (41 mm)	12	25.34 (6.93)
16E1	16-Compartment Full Drop Extender	19⅝" x 19⅝" x 2" (499 x 499 x 51 mm)	4⅝" x 4⅝" (111 x 111 mm)	1⅝" (41 mm)	12	23.30 (6.93)
20GE1	20-Compartment Full Drop Extender	19⅝" x 19⅝" x 2" (499 x 499 x 51 mm)	3⅝" x 3⅝" (98 x 98 mm)	1⅝" (41 mm)	12	25.8 (7.33)
25E1	25-Compartment Full Drop Extender	19⅝" x 19⅝" x 2" (499 x 499 x 51 mm)	3½" x 3½" (89 x 89 mm)	1⅝" (41 mm)	12	25.46 (6.93)
30GE1	30-Compartment Full Drop Extender	19⅝" x 19⅝" x 2" (499 x 499 x 51 mm)	3⅝" x 3⅝" (79 x 79 mm)	1⅝" (41 mm)	12	28.4 (7.33)
36E1	36-Compartment Full Drop Extender	19⅝" x 19⅝" x 2" (499 x 499 x 51 mm)	2⅝" x 2⅝" (73 x 73 mm)	1⅝" (41 mm)	12	28.02 (6.93)
49E1	49-Compartment Full Drop Extender	19⅝" x 19⅝" x 2" (499 x 499 x 51 mm)	2⅝" x 2⅝" (62 x 62 mm)	1⅝" (41 mm)	12	32.30 (6.93)
Full Size Half Drop Extenders – E2 and G2						
9E2	9-Compartment Half Drop Extender	19⅝" x 19⅝" x 2" (499 x 499 x 51 mm)	5⅝" x 5⅝" (150 x 150 mm)	1⅝" (41 mm)	12	21.62 (6.93)
16E2	16-Compartment Half Drop Extender	19⅝" x 19⅝" x 2" (499 x 499 x 51 mm)	4⅝" x 4⅝" (111 x 111 mm)	1⅝" (41 mm)	12	21.75 (6.93)
20E2	20-Compartment Half Drop Extender (for cups only)	19⅝" x 19⅝" x 2" (499 x 499 x 51 mm)	4⅝" x 3½" (111 x 89 mm)	1⅝" (41 mm)	12	22.22 (6.93)
20GE2	20-Compartment Half Drop Extender	19⅝" x 19⅝" x 2" (499 x 499 x 51 mm)	3⅝" x 3⅝" (98 x 98 mm)	1⅝" (41 mm)	12	23.4 (7.33)
25E2	25-Compartment Half Drop Extender	19⅝" x 19⅝" x 2" (499 x 499 x 51 mm)	3½" x 3½" (89 x 89 mm)	1⅝" (41 mm)	12	23.06 (6.93)
30GE2	30-Compartment Half Drop Extender	19⅝" x 19⅝" x 2" (499 x 499 x 51 mm)	3⅝" x 3⅝" (79 x 79 mm)	1⅝" (41 mm)	12	25.2 (7.33)

Camrack® / PlateSafe® Component System

CODE	DESCRIPTION	OVERALL DIMENSIONS	COMPARTMENT	INSIDE RACK HEIGHT	CASE PACK	CASE LBS. (CUBE)
Full Size Half Drop Extenders – E2 and GE2 (continued)						
36E2	36-Compartment Half Drop Extender	19 $\frac{5}{8}$ " x 19 $\frac{5}{8}$ " x 2" (499 x 499 x 51 mm)	2 $\frac{7}{8}$ " x 2 $\frac{7}{8}$ " (73 x 73 mm)	1 $\frac{5}{8}$ " (41 mm)	12	25.58 (6.93)
49E2	49-Compartment Half Drop Extender	19 $\frac{5}{8}$ " x 19 $\frac{5}{8}$ " x 2" (499 x 499 x 51 mm)	2 $\frac{7}{16}$ " x 2 $\frac{7}{16}$ " (62 x 62 mm)	1 $\frac{5}{8}$ " (41 mm)	12	28.10 (6.93)
Full Size Open Extender – E3						
E3	Open Extender	19 $\frac{5}{8}$ " x 19 $\frac{5}{8}$ " x 2" (499 x 499 x 51 mm)	18" x 18" (457 x 457 mm)	1 $\frac{5}{8}$ " (41 mm)	12	16.90 (5.52)
Full Size Full Drop Extender – E4						
16E4	16-Compartment Full Drop Extender	19 $\frac{5}{8}$ " x 19 $\frac{5}{8}$ " x 2" (499 x 499 x 51 mm)	4 $\frac{3}{8}$ " x 4 $\frac{3}{8}$ " (111 x 111 mm)	1 $\frac{5}{8}$ " (41 mm)	12	26.78 (6.93)
25E4	25-Compartment Full Drop Extender	19 $\frac{5}{8}$ " x 19 $\frac{5}{8}$ " x 2" (499 x 499 x 51 mm)	3 $\frac{1}{2}$ " x 3 $\frac{1}{2}$ " (89 x 89 mm)	1 $\frac{5}{8}$ " (41 mm)	12	30.38 (6.93)
36E4	36-Compartment Full Drop Extender	19 $\frac{5}{8}$ " x 19 $\frac{5}{8}$ " x 2" (499 x 499 x 51 mm)	2 $\frac{7}{8}$ " x 2 $\frac{7}{8}$ " (73 x 73 mm)	1 $\frac{5}{8}$ " (41 mm)	12	34.34 (6.93)
Full Size Half Drop Extender – E5						
16E5	16-Compartment Half Drop Extender	19 $\frac{5}{8}$ " x 19 $\frac{5}{8}$ " x 2" (499 x 499 x 51 mm)	4 $\frac{3}{8}$ " x 4 $\frac{3}{8}$ " (111 x 111 mm)	1 $\frac{5}{8}$ " (41 mm)	12	25.34 (6.93)
25E5	25-Compartment Half Drop Extender	19 $\frac{5}{8}$ " x 19 $\frac{5}{8}$ " x 2" (499 x 499 x 51 mm)	3 $\frac{1}{2}$ " x 3 $\frac{1}{2}$ " (89 x 89 mm)	1 $\frac{5}{8}$ " (41 mm)	12	28.22 (6.93)
36E5	36-Compartment Half Drop Extender	19 $\frac{5}{8}$ " x 19 $\frac{5}{8}$ " x 2" (499 x 499 x 51 mm)	2 $\frac{7}{8}$ " x 2 $\frac{7}{8}$ " (73 x 73 mm)	1 $\frac{5}{8}$ " (41 mm)	12	31.34 (6.93)
Half Size Full Drop Extenders – HE1						
8HE1	8-Compartment Full Drop Extender	19 $\frac{3}{4}$ " x 9 $\frac{7}{8}$ " x 2" (502 x 252 x 51 mm)	4 $\frac{1}{8}$ " x 4 $\frac{7}{16}$ " (105 x 113 mm)	1 $\frac{5}{8}$ " (41 mm)	12	14.10 (3.54)
10HE1	10-Compartment Full Drop Extender	19 $\frac{3}{4}$ " x 9 $\frac{7}{8}$ " x 2" (502 x 252 x 51 mm)	4 $\frac{1}{8}$ " x 3 $\frac{1}{2}$ " (105 x 89 mm)	1 $\frac{5}{8}$ " (41 mm)	12	15.06 (3.54)
17HE1	17-Compartment Full Drop Extender	19 $\frac{3}{4}$ " x 9 $\frac{7}{8}$ " x 2" (502 x 252 x 51 mm)	∅ 2 $\frac{15}{16}$ " (∅ 74 mm)	1 $\frac{5}{8}$ " (41 mm)	12	17.46 (3.54)
Half Size Half Drop Extenders – HE2						
8HE2	8-Compartment Half Drop Extender	19 $\frac{3}{4}$ " x 9 $\frac{7}{8}$ " x 2" (502 x 252 x 51 mm)	4 $\frac{1}{8}$ " x 4 $\frac{7}{16}$ " (105 x 113 mm)	1 $\frac{5}{8}$ " (41 mm)	12	13.62 (3.54)
10HE2	10-Compartment Half Drop Extender	19 $\frac{3}{4}$ " x 9 $\frac{7}{8}$ " x 2" (502 x 252 x 51 mm)	4 $\frac{1}{8}$ " x 3 $\frac{1}{2}$ " (105 x 89 mm)	1 $\frac{5}{8}$ " (41 mm)	12	14.34 (3.54)
17HE2	17-Compartment Half Drop Extender	19 $\frac{3}{4}$ " x 9 $\frac{7}{8}$ " x 2" (502 x 252 x 51 mm)	∅ 2 $\frac{15}{16}$ " (∅ 74 mm)	1 $\frac{5}{8}$ " (41 mm)	12	15.90 (3.54)
Half Size Open Extenders – HE3						
HE3	Open Extender	19 $\frac{3}{4}$ " x 9 $\frac{7}{8}$ " x 2" (502 x 252 x 51 mm)	18 $\frac{3}{4}$ " x 8 $\frac{3}{8}$ " (464 x 213 mm)	1 $\frac{5}{8}$ " (41 mm)	12	11.94 (3.54)

∅ = Diameter

PlateSafe Camrack Grids

CODE	DESCRIPTION	DIMENSIONS	CASE PACK	CASE LBS (CUBE)
Full Size PlateSafe Grids				
CRPG6345	Holds 63 plates, 4"-5"	18" x 18"	12	28.82 (0.92)
CRPG2046	Holds 20 plates, 4"-6"	18" x 18"	12	17.29 (0.92)
CRPG4856	Holds 48 plates, 5"-6"	18" x 18"	12	26.83 (0.92)
CRPG4467	Holds 44 plates, 6"-7"	18" x 18"	12	26.23 (0.92)
CRPG3067	Holds 30 plates, 6"-7 $\frac{5}{8}$ "	18" x 18"	12	21.79 (0.92)
CRPG2878	Holds 28 plates, 7"-8 $\frac{5}{8}$ "	18" x 18"	12	21.44 (0.92)
CRPG20910	Holds 20 plates, 9"-10 $\frac{1}{4}$ "	18" x 18"	12	19.93 (0.92)
CRPG12910	Holds 12 plates, 9"-10 $\frac{1}{2}$ "	18" x 18"	12	15.91 (0.92)
CRPG12911	Holds 12 plates, 9"-11 $\frac{1}{8}$ "	18" x 18"	12	17.71 (0.92)
CRPG9911	Holds 9 plates, 9"-11"	18" x 18"	12	14.53 (0.92)
CRPG191011	Holds 19 plates, 10"-11"	18" x 18"	12	19.91 (0.92)
CRPG141012	Holds 14 plates, 10 $\frac{1}{2}$ "-12 $\frac{1}{2}$ "	18" x 18"	12	17.29 (0.82)
CRPG181112	Holds 18 plates, 11"-12 $\frac{1}{2}$ "	18" x 18"	12	21.10 (0.92)
Half Size PlateSafe Grid				
CRPHG1656	Holds 16 plates, 5"-6 $\frac{7}{8}$ "	18 $\frac{1}{4}$ " x 8 $\frac{3}{8}$ "	12	13 (0.49)
PlateSafe Hold Down Grid				
CRPHDG2878	Fits all full size base racks	18" x 18"	6	11.05 (0.49)

Base Rack Colors: Sherwood Green (119), Soft Gray (151), Brown (167), Beige (184), Navy Blue (186), Cranberry (416), Black (110)*, Red (163)*, Blue (168)*, Teal (414)*. **Base Cup Rack Color:** Soft Gray (151). **Extender Color:** Soft Gray (151). * Color available in full size only. All extenders are available in Soft Gray (151). All pre-assembled racks ship with Soft Gray (151) extenders. Sherwood Green, Brown, Navy Blue and Cranberry base racks can be ordered with same color extenders with a minimum special order of 600 racks.

PlateSafe Grid Color: Gray (000).

Promote Your Brand – Personalized Camracks®

Personalize Camracks to identify contents at a glance for accurate inventory control and selection.

Hot stamp a custom logo, information or standard content symbols, and/or descriptions on two opposite, diagonal sides of any rack.

Or request the addition of pre-printed clips. Up to 4 Camrack or PlateSafe clips can be added **only at time of assembly** and require the addition of at least one extender.



IMPRINT COLOR-WHITE



PERSONALIZATION OPTIONS

HOT STAMPING



CUSTOM LOGO AND/OR TEXT



STANDARD SYMBOL ONLY



STANDARD SYMBOL AND DESCRIPTION



STANDARD DESCRIPTION ONLY

CAMRACK CLIPS



WITH SYMBOL AND DESCRIPTION

HOW TO ORDER A SAMPLE

1. Contact your local Cambro rep to complete and submit a sample request form to Cambro. Indicate location of hot stamp and/or clip on rack. Maximum hot stamp imprint size is 4" W x 1 ¼" H. Maximum hot stamp imprinting thickness per solid letter or logo should be no more than 4" wide.
2. If selecting custom hot stamping, provide ready-to-use artwork, in digital format only. Sample request form must be submitted to Cambro **PRIOR** to artwork being sent. If artwork is incomplete, graphic support services are available for \$ 50.00 per hour.
3. E-mail artwork to Cambro Rep or to Cambro at letsgetpersonal@cambro.com. Title e-mail subject with logo name and provide contact info.

File dimensions:
100% reproduction size, 300dpi resolution.

File type: Adobe® Illustrator®, Photoshop®, or QuarkXpress®.

File format: JPEG, TIFF or EPS.

Or mail artwork on a CD-ROM to: Cambro Manufacturing Company
Attn: Kristie Patterson,
7601 Clay Avenue,
Huntington Beach, CA 92648.
4. Questions? Contact Kristie Patterson at 714-230-4125 direct or 800-854-7631 ext. 4125.
5. Signed approval form must be faxed to Cambro customer service prior to producing product. Approval form included with each sample rack.

PERSONALIZATION CHARGES (NET)

One Time Plate Charge	\$ 75.00 (for custom hot stamp only)
Set-Up Charge	\$ 50.00
Sample Charge	\$ 50.00
Imprint Charge	\$ 1.00 per side, 2 sides max

FOR CLIPS

Drinkware or PlateSafe®, pre-printed	\$ 0.90 each net
--------------------------------------	------------------

Standard Hot Stamp Symbols and/or Descriptions

(also available on clips, symbol and description combined)

- | | |
|--|--|
|  Wine |  Cup |
|  Martini |  Champagne Flute |
|  Rock (footed style) |  Grande |
|  Beer Mug |  Goblet |
|  Hi-Ball |  Sorbet |
|  Hurricane |  Rock (tumbler style) |
|  White Wine |  Creamer |
|  Brandy |  Beer |
|  Water (footed style) |  Collins |
|  Coffee Mug |  Champagne |
|  Margarita |  Cordial |
|  Pilsner |  Ice Tea |
|  Red Wine |  Decanter |
|  Sherry |  Old Fashion |
|  Water (tumbler style) |  Flatware |



(Available in English Only)

Standard PlateSafe® Clips

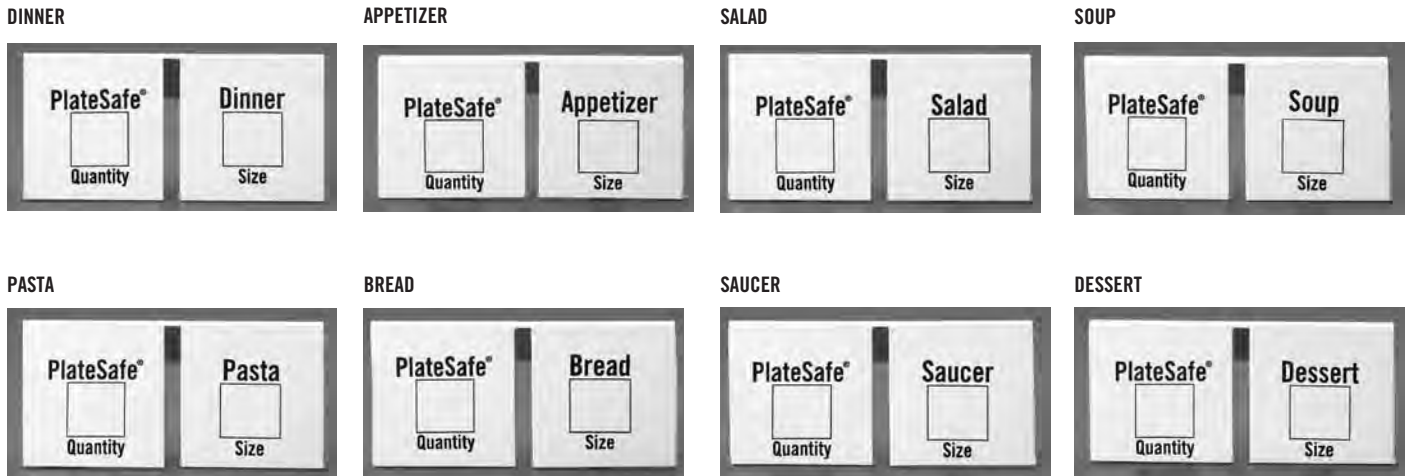

(Available in English Only)

Camrack® Cup Rack Reference Guide



16

FULL RACK

COMPARTMENT

4³/₈" x 4³/₈" (11,1 x 11,1 cm)

QUICK GUIDE

Full Size Cup Racks (C)

Maximum Cup Width	Number of Compartments	Maximum Cup Height		
		2 ⁵ / ₈ " (6,6 cm)	4 ¹ / ₄ " (10,7 cm)	5 ⁷ / ₈ " (14,9 cm)
4 ³ / ₈ " (11,1 cm)	16	16C258	16C414	16C578
3 ¹ / ₂ " (8,8 cm)	20	20C258	20C414	NA

To determine Cup compartment size:
Turn cup or coffee mug upside down and place diagonally in square. Align handle with arrow in square. Cup or mug and handle must fit completely within boundaries of a square in order to ensure the right rack.



20

FULL RACK

COMPARTMENT

4³/₈" x 3¹/₂" (11,1 x 8 cm)



10

HALF RACK

COMPARTMENT

4¹/₈" x 3¹/₂" (10,4 x 8,8 cm)



8

HALF RACK

COMPARTMENT

4⁷/₁₆" x 4¹/₈" (11,3 x 10,4 cm)

QUICK GUIDE

Half Size Cup Racks (HC)

Maximum Cup Width	Number of Compartments	Maximum Cup Height	
		2 ⁵ / ₈ " (6,6 cm)	4 ¹ / ₄ " (10,7 cm)
4 ¹ / ₈ " (10,4 cm)	8	8HC258	8HC414
3 ¹ / ₂ " (8,8 cm)	10	10HC258	10HC414

To Determine Cup Height:

Place base of cup or coffee mug on flat surface hold ruler vertically next to it to determine height in inches or millimeters. If the height is greater than 4¹/₄" (108 mm), additional 1⁵/₈" (41 mm) E2 and HE2 extenders may be ordered.

Stemware and Glass Sizing Reference Guide

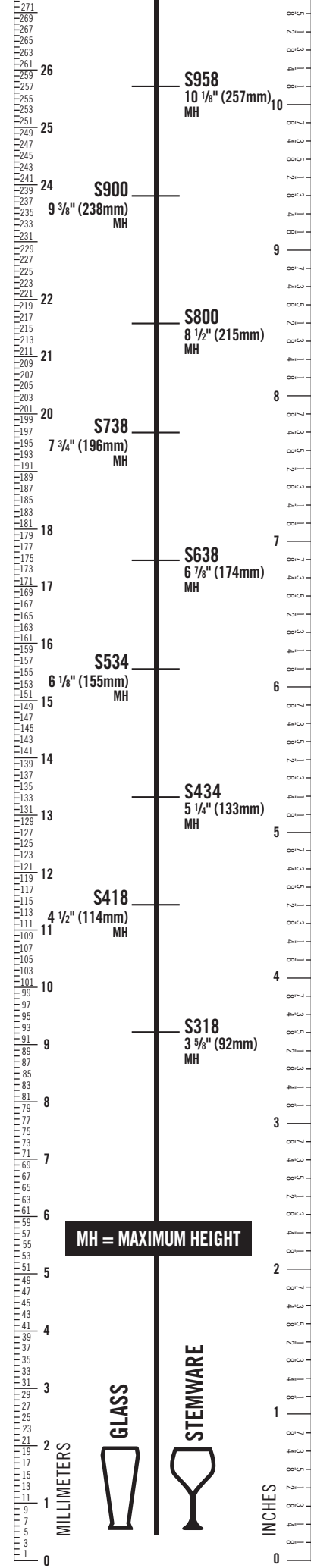

S958
10 1/8" (257mm)
MH

S900
9 3/8" (238mm)
MH

S800
8 1/2" (215mm)
MH

S738
7 3/4" (196mm)
MH

S638
6 7/8" (174mm)
MH

S534
6 1/8" (155mm)
MH

S434
5 1/4" (133mm)
MH

S418
4 1/2" (114mm)
MH

S318
3 5/8" (92mm)
MH

To Determine Compartment Size

- **Half Size Racks:** Place glass or stemware upside down over circle chart. Look down on the glass. Whatever circle the largest diameter of the glass fits within will determine the number of compartments.
- **Full Size Racks:** Place glass or stemware upside down over circle chart. Look down on the glass. Whatever circle the largest diameter of the glass fits within will determine the number of compartments.

Use the vertical guide marks at right to determine item height and appropriate rack number.

